



# RIANT WHEEL

Design & Made in Taiwan

---

## CATALOG

PU solid tires, wheels, caster & the other accessories with High-Quality & Reliable



# We come from Taiwan.

## Application on

Manual & Electric wheelchair,  
Agriculture devices,  
Storage transportation devices,  
Cleaning devices,  
Sports equipment,  
Boat trailers,  
Unmanned Vehicle.

## Our Advantage

Fine Machining Technology  
For better Smoothness of rolling  
Less vibration  
Abrasion Resistance  
Better durability  
Experienced Skills  
Stability of quality  
Uniformity of production

## Reliability Test



# OUR SERVICE

Your Trustworthy Partner from Taiwan.

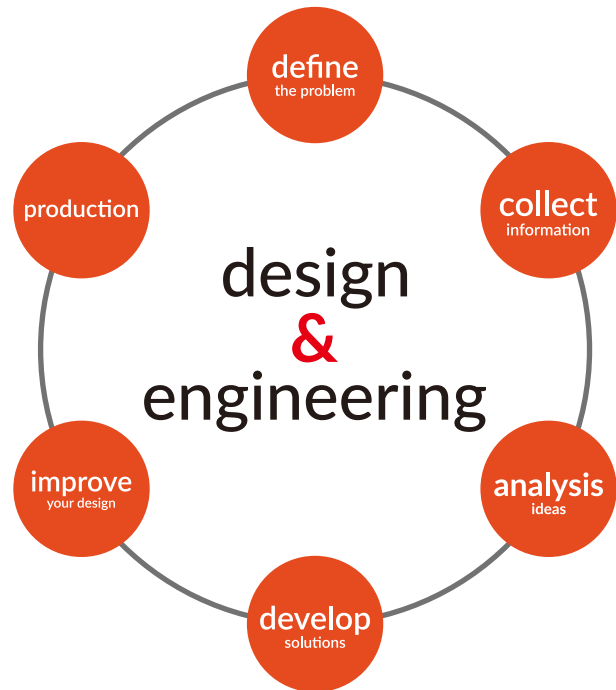

## Plastic Rubber & Silicon

- Plastic Injection
- Rubber / Silicon Forming



## Metal Manufacture

- Die Casting for Aluminum & Zinc
- NTC & Stamping for Steel
- CNC Machining (3~5-axis machining)
- MIM



## Titanium 64 Processing & Finish

- Ti64 - Machining
- Colour-Anodising for Titanium Alloy



## Metal Surface Special Treatment

- Electroless Nickel Plating with Dispersed PTFE
- Plasma Chemical Coating
- Hard Anodising for Aluminum
- Black Oxide for Stainless Steel
- Stainless Steel Mirror Polished



# Polyurethane Tire with Aluminum - Soft Roll Caster Series

Concentric Improving / High Strength / Ultra Light Weight / Comfort / Precision



Model No.  
PWA335U00Bx00

W335 - 3" x 1.4"

3.0"	1.4"	1.0"	0.3"(8.0mm)	688	66lb / 30kg	

Rim Color Available : Silver (S) / Black(B) / Blue(L) / Red(R) / Green (G) / Gold (A) / Purple(Z)



Model No.  
PWA435U00Bx00  
PWA425U00Bx00

W435 - 4" x 1.4" / W425 - 4" x 1.0"

4.0"	1.4"	1.0"	0.3"(8.0mm)	608	110lb / 50kg	
4.0"	1.0"	1.0"	0.3"(8.0mm)	608	110lb / 50kg	

Rim Color Available : Anodize : Silver (S) / Black(B) / Blue(L) / Red(R) / Green (G) / Gold (A) / Purple (Z)  
Coating : White (W)



Model No.  
PWA535U00Bx00  
PWA525U00Bx00

W535 - 5" x 1.4" / W525 - 5" x 1.0"

5.0"	1.4"	1.0"	0.3"(8.0mm)	608	110lb / 50kg	
5.0"	1.0"	1.0"	0.3"(8.0mm)	608	110lb / 50kg	

Rim Color Available : Anodize : Silver (S) / Black(B) / Blue(L) / Red(R) / Green (G) / Gold (A) / Purple (Z)  
Coating : White (W)



Model No.  
PWA635U00Bx00

W635 - 6" x 1.4"

6.0"	1.4"	1.0"	0.3"(8.0mm)	608	110lb / 50kg	

Rim Color Available : Anodize : Silver (S) / Black(B) / Blue(L) / Red(R) / Green (G) / Gold (A) / Purple (Z)  
Coating : White (W)



# Polyurethane Tire with Plastic Rim Series



Model No.  
PWN434U30Bx00

W434- 4" (100x35mm)

2024 NEW!



4.0" (100mm)



1.4"(35mm)



1.0"(25.4mm)



110lb / 50kg

**Color Available**

Black (B)  
Blue (L)  
Green (G)  
Orange (T)  
Red (R)  
Yellow (Y)

**Pantone Color**

-  
3005C  
354C  
1505C  
186C  
012C



Model No.  
PWN534U30Bx00

W534- 5" (125x35mm)

2024 NEW!



5.0" (125mm)



1.4"(35mm)



1.0"(25.4mm)



110lb / 50kg

**Color Available**

Black (B)  
Blue (L)  
Green (G)  
Orange (T)  
Red (R)  
Yellow (Y)

**Pantone Color**

-  
3005C  
354C  
1505C  
186C  
012C









# Polyurethane Tire with Plastic Rim Series



Model No.  
PWN514U50BB00







## W514- 5" (125x35mm) - 5 Spoke

					
5.0" (125mm)	1.4"(35mm)	1.4"(42mm)	0.3"(8.0mm)	608	110lb / 50kg



Model No.  
PWN614U50BB00



## W614- 5" (150x35mm) - 5 Spoke

					
6.0" (150mm)	1.4"(35mm)	1.4"(42mm)	0.3"(8.0mm)	608	110lb / 50kg



Model No.  
PWN714U50BB00  
PWN714U70BB00  
PWN716U50BB00  
PWN716U70BB00







## W714 - 7" (175x40mm) - 5 Spoke / 7 Spoke

					
7.0" (175mm)	1.6"(40mm)	1.6"(40mm)	0.3"(8.0mm)	608	110lb / 50kg
7.0" (175mm)	1.6"(40mm)	1.6"(60mm)	0.3"(8.0mm)	608	110lb / 50kg
7.0" (175mm)	1.6"(40mm)	2.4"(40mm)	0.3"(8.0mm)	608	110lb / 50kg
7.0" (175mm)	1.6"(40mm)	2.4"(60mm)	0.3"(8.0mm)	608	110lb / 50kg



Model No.  
PWN814U50BB00  
PWN814U70BB00  
PWN816U50BB00  
PWN816U70BB00

## W814 - 8" (200x40mm) - 5 Spoke(320g) / 7 Spoke(420g)

					
8.0" (200mm)	1.6"(40mm)	1.6"(40mm)	0.3"(8.0mm)	608	110lb / 50kg
8.0" (200mm)	1.6"(40mm)	1.6"(60mm)	0.3"(8.0mm)	608	110lb / 50kg
8.0" (200mm)	1.6"(40mm)	2.4"(40mm)	0.3"(8.0mm)	608	110lb / 50kg
8.0" (200mm)	1.6"(40mm)	2.4"(60mm)	0.3"(8.0mm)	608	110lb / 50kg



# Polyurethane Tire with Plastic Rim Series



Model No.  
PWN106U51BB00

W105- 10" (250x33mm) -Weight : 490g (±5%)



10" (250mm)



1.3"(33mm)



2.1"(54mm)



0.47"(12.0mm)



6201



110lb / 50kg



Model No.  
PWN125U5ABB00  
(Standard Type PU)

W125B- 12" (305x54mm) -Weight : 1,030g (±5%) / (Standard Type PU)



12" (305mm)



1.6"(40mm)



2.1"(54mm)



0.47"(12.0mm)



6201



110lb / 50kg



Model No.  
PWN126U51BBB0  
(Economic Type PU)

W126B- 11" (285x54mm) -Weight : 640g (±5%) / (Economic Type PU)



11" (285mm)



1.6"(40mm)



2.1"(54mm)



0.47"(12.0mm)



6201



110lb / 30kg



Model No.  
PWN146U51BB00

W145- 14" (285x55mm) -Weight : 930g (±5%)



14" (340mm)



1.6"(40mm)



2.2"(55mm)



0.47"(12.0mm)



6001



110lb / 50kg



# Polyurethane Tire with Plastic Rim Series



W165- 16" (384x40mm) -Weight : 1,050g (±5%)

Model No.  
PWN186U51BB00



16" (384mm)



1.6"(40mm)



2.4"(58mm)



0.47"(12.0mm)



6001



110lb / 50kg



W188- 18" (447x40mm) -Weight : 1,330g (±5%)

Model No.  
PWN186U51BB00



18" (447mm)



1.6"(40mm)



2.0"(50mm)



0.47"(12.0mm)



6001



110lb / 50kg





# Polyurethane Tire with Plastic Rim Series



Adapt for most Rollator & Walker  
W524- 5" x 0.9" (125x35mm) - 5 Spoke

Model No.  
PWN524U50BV00



5.0" (125mm) 0.9"(23mm) 1.1"(27.4mm) 0.3"(8.0mm) 110lb / 50kg

## Solid Casters - Small but Strong



Model No.

WS-208

WS-209

WS-211

WS-271

WS-301



2.0" /50mm

2.0" /50mm

2.1" /54mm

2.7" /68mm

3.0"/76mm



0.8" /20mm

0.9"/23mm

1.0"/24mm

1.0"/24mm

1.0"/24mm



0.25" (6.4mm)

0.3" (8mm)

0.3" (8mm)

0.3" (8mm)

0.3" (8mm)



0.9"/23.5mm

1.0"/26.0mm

0.9"/23.5mm

1.0"/24.0mm

1.0"/24.0mm



Bearing 608

Bearing 608

Bearing 608

Bearing 608

Material

Nylon

Nylon + PVC

Nylon + PU

Nylon + PVC

Nylon + PU



# PU Solid Tire - Sport Series (Flat Free Tire)

**High Rebound & Ultra Light Weight. (Insert Forming, Non Glued Combination.)**

1. Specialized PU Material Fomular
2. Efficiency & Effectiveness
3. Suitable for Multi-Type Pavement
4. Anti-puncture

## The advantages of our integrated insert forming rim & tire

- |   |  |
|---|--|
| <ul style="list-style-type: none"> <li>under heavy loading</li> <li>under high speed</li> <li>under long time used</li> </ul> | <ul style="list-style-type: none"> <li>- no separate</li> <li>- no displacement</li> <li>- no deformation</li> </ul> |
|---|--|

**Not only lightweight,  
but aslo strong reliability**



**RN6S - 6" (150x40mm) -Weight : 420g (±5%)**

Model No.  
PWN154B6CBB00  
PWN154B5CBB00

6.0" (150mm)	1.6"(40mm)	2.4"(60mm)	0.3"(8.0mm)	608	110lb / 50kg
6.0" (150mm)	1.6"(40mm)	2.0"(51mm)	0.3"(8.0mm)	608	110lb / 50kg

Color Available : Black / Gray



**RN6U - 6" (150x45mm) -Weight : 450g (±5%)**

Model No.  
PWN155B6CBBB0  
PWN155B5CBBB0

6.0" (150mm)	1.8"(45mm)	2.4"(60mm)	0.3"(8.0mm)	608	110lb / 50kg
6.0" (150mm)	1.8"(45mm)	2.0"(51mm)	0.3"(8.0mm)	608	110lb / 50kg

Color Available : Black / Gray



# PU Solid Tire - Sport Series (Flat Free Tire)



## RN7C - 7" (175x45mm) -Weight : 540 g (±5%)

Model No.
PWN175B6CBBB0
PWN175B5CBBB0

7.0" (175mm)	1.8"(45mm)	2.4"(60mm)	0.3"(8.0mm)	608	110lb / 50kg
7.0" (175mm)	1.8"(45mm)	2.0"(51mm)	0.3"(8.0mm)	608	110lb / 50kg

Color Available : Black / Gray



## RN7S - 7" (175x45mm) -Weight : 520g (±5%)

Model No.
PWN174B6CBB00
PWN174B5CBB00

7.0" (175mm)	1.8"(45mm)	2.4"(60mm)	0.3"(8.0mm)	608	110lb / 50kg
7.0" (175mm)	1.8"(45mm)	2.0"(51mm)	0.3"(8.0mm)	608	110lb / 50kg

Color Available : Black / Gray



## RN8U - 8" (200x60mm) -Weight : 820(±5%)

Model No.
PWN206A4EBB00
PWN206B4EBB00
PWN206B6CBB00
PWN206D4EBB00
PWN206E4EBB00

8.0" (200mm)	2.4"(60mm)	1.6"(40mm) (Eccentric)	-	Quick Release 19mm	110lb / 50kg
8.0" (200mm)	2.4"(60mm)	1.6"(40mm) (Eccentric)	0.5"(12.0mm)	6201	110lb / 50kg
8.0" (200mm)	2.4"(60mm)	2.0"(60mm) (Centric)	0.5"(12.0mm)	6201	110lb / 50kg
8.0" (200mm)	2.4"(60mm)	1.6"(40mm) (Eccentric/with cap)	-	Quick Release 19mm	110lb / 50kg
8.0" (200mm)	2.4"(60mm)	1.6"(40mm) (Eccentric/with cap)	0.5"(12.0mm)	6201	110lb / 50kg

Tyre Color Available : Black / Gray



## RN - 2.8/2.5 - 4" -Weight : 985 g (±5%)

Model No.
PWN286A4EBB00
PWN286B4EBB00
PWN286B6CBB00

8.6" (218mm)	2.8"(72mm)	1.6"(40mm) (Eccentric)	-	Quick Release 19mm	110lb / 50kg
8.6" (218mm)	2.8"(72mm)	1.6"(40mm) (Eccentric)	0.47"(12.0mm)	6201	110lb / 50kg
8.6" (218mm)	2.8"(72mm)	2.0"(60mm) (Centric)	0.47"(12.0mm)	6201	110lb / 50kg

Color Available : Black / Gray



# PU Solid Tire - Sport Series (Flat Free Tire)



Model No.
PWN205A4EBB00
PWN205B4EBB00
PWN205B6CBB00

RN8S - 8" (200x50mm) -Weight : 730g (±5%)



8.0" (200mm)	2.0"(50mm)	1.6"(40mm) (Eccentric)	-	Quick Release 19mm	110lb / 50kg
8.0" (200mm)	2.0"(50mm)	1.6"(40mm) (Eccentric)	0.47"(12.0mm)	6201	110lb / 50kg
8.0" (200mm)	2.0"(50mm)	2.0"(60mm) (Centric)	0.47"(12.0mm)	6201	110lb / 50kg

Color Available : Black / Gray



Model No.
PWN2U5A4EBB00
PWN2U5B4EBB00
PWN2U5B6CBB00

RN8U - 8" (200x50mm) -Weight : 820g (±5%)



8.0" (200mm)	2.0"(50mm)	1.6"(40mm) (Eccentric)	-	Quick Release 19mm	110lb / 50kg
8.0" (200mm)	2.0"(50mm)	1.6"(40mm) (Eccentric)	0.47"(12.0mm)	6201	110lb / 50kg
8.0" (200mm)	2.0"(50mm)	2.0"(60mm) (Centric)	0.47"(12.0mm)	6201	110lb / 50kg

Color Available : Black / Gray



Model No.
PWN207A4EBB00
PWN207B4EBB00
PWN207B6CBB00

RN8F - 8" (200x70mm) -Weight : 900g (±5%)



8.0" (200mm)	2.75"(70mm)	1.6"(40mm) (Eccentric)	-	Quick Release 19mm	110lb / 50kg
8.0" (200mm)	2.75"(70mm)	1.6"(40mm) (Eccentric)	0.47"(12.0mm)	6201	110lb / 50kg
8.0" (200mm)	2.75"(70mm)	2.0"(60mm) (Centric)	0.47"(12.0mm)	6201	110lb / 50kg

Color Available : Black / Gray



Model No.
PWN225A4EBB00
PWN225B4EBB00
PWN225B6CBB00

RN9U - 9" (225x55mm) -Weight : 1,020g (±5%)



9.0" (200mm)	2.2"(55mm)	1.6"(40mm) (Eccentric)	-	Quick Release 19mm	110lb / 50kg
9.0" (200mm)	2.2"(55mm)	1.6"(40mm) (Eccentric)	0.47"(12.0mm)	6201	110lb / 50kg
9.0" (200mm)	2.2"(55mm)	2.0"(60mm) (Centric)	0.47"(12.0mm)	6201	110lb / 50kg

Color Available : Black / Gray



# Forks & Sub-Assembly Solutions

Excellent Smoothness in Omni-Directional Maneuver



Model No.  
SF458W335fx00  
SF458W435fx00 / SF458W425fx00  
SF458W535fx00 / SF458W525fx00  
SF458W635fx00

## FK458 Series with Aluminum Soft Roll Casters

Suggest Wheels Used : 3", 4", 5", 6"  
Material : Aluminum 6061 T6 / Finish : Anodizing  
Fork Color Available : Silver (S) / Black(B)



Model No.  
SF488W335fx00  
SF488W435fx00 / SF488W425fx00  
SF488W535fx00 / SF488W525fx00  
SF488W635fx00

## FK488 Series with Aluminum Soft Roll Casters

Suggest Wheels Used : 3", 4", 5", 6"  
Material : Aluminum 6061 T6 / Finish : Anodizing  
Fork Color Available : Silver (S) / Black(B)  
with  
Bearing : R8  
Bolt : M12 / Customized available



Model No.  
SFK12W335fx00  
SFK12W435fx00 / SFK12W425fx00  
SFK12W535fx00 / SFK12W525fx00  
SFK12W635fx00

## FK12 Series with Aluminum Soft Roll Casters

Suggest Wheels Used : 3", 4", 5", 6"  
Material : Aluminum 6061 T6 / Finish : Anodizing  
Fork Color Available : Silver (S) / Black(B)  
with  
Bearing : R8  
Bolt : M12 / Customized available



FK64 + W514



FK64 + W514



FK74 + W714



FK84 + W814



FK86 + RN7

## Nylon Fork Series with Nylon Rim PU Casters

For adapted the other size casters, Please contact with us.  
Material : Fork : PA6+GF20% / Fork Color Available : Black(B)  
FK64 + W514  
FK64ex + W614  
FK74 + W714  
FK84 + W814  
FK86 + RN7

Model No.  
SF640W514BB00  
SF64xW614BB00  
SF740W714BB00  
SF840W814BB00  
SF860ARN7BB00



# Spoke Wheels

BASIC

STROLLING

EXPLOER

RX16

RXR

## Code principles :

C  
↓

series:

B (with handrim)

C (no handrim)

24  
↓

size:

24"

22"

20"

18"

16"

14"

26  
↓

rim:

6N (P6N)

7N (P7N)

8T (P8T)

26 (P26)

DX (DX188)

D  
↓

hub:

C

N

M

L

D

R

6  
↓

bearing:

6 (6001)

8 (R8)

36  
↓

spoke:

20

28

36

S  
↓

tire tread:

0 (No tire)

S (Standard, PU)

P (Sport, PU)

A  
↓

tire width:

0 (No tire)

A (1 3/8")

B (1.75")

00  
↓

detail serial

# STANDARD - BASIC



## OVERVIEW

SPOKE SIZE 14G, 36pcs, Silver/Black  
 24"  
 22"  
 20"

Part No.  
 B2426D836SA00  
 Available  
 Available



## RIM

TYPE P26, Single Wall  
 MATERIAL Aluminium  
 COLOR Silver/Black

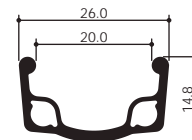

## HUB

TYPE D Type  
 MATERIAL Aluminium  
 COLOR Silver/Black



## TIRE

TYPE Standard  
 MATERIAL PU Solid tire  
 COLOR Black/Gray  
 WIDTH 1 3/8"



## HANDRIM

TYPE Economic  
 MATERIAL Silver  
 COLOR Stainless Steel  
 MOUNTING Rivet Nuts (6H)



[Welcome to contact us for more information.](#)



# STANDARD - STROLLING



## OVERVIEW

SPOKE 14G, 28pcs, Silver/Black  
 SIZE 24"  
 22"  
 20"

Part No.  
**C2426B828PA00**  
 Available  
 Available



## RIM

TYPE P26, Single Wall  
 MATERIAL Aluminium  
 COLOR Silver/Black

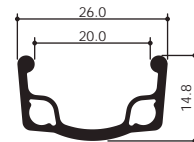

## HUB

TYPE Drum Brake Hub  
 MATERIAL Aluminium  
 COLOR Silver



R8



12.7 mm



43.2 mm



79.0 mm



## TIRE

TYPE Standard  
 MATERIAL PU Solid tire  
 COLOR Black/Gray  
 WIDTH 1 3/8"



Welcome to contact us for more information.





# STANDARD - EXPLOER



## OVERVIEW

SPOKE 14G, 20pcs, Silver/Black  
 SIZE 18"  
 16"  
 14"

Part No.  
**C188TM620SB01**  
 Available  
 Available



## RIM

TYPE P8T, Single Wall  
 MATERIAL Aluminium  
 COLOR Silver/Black

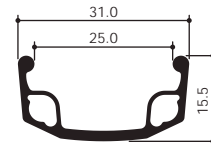

## HUB

TYPE M Type  
 MATERIAL Aluminium  
 COLOR Silver/Black



6001



12.0 mm



53.0 mm



63.5 mm



## TIRE

TYPE Standard  
 MATERIAL PU Solid tire  
 COLOR Black/Gray  
 WIDTH 1.75"



[Welcome to contact us for more information.](#)



2024 NEW!

# SUPERIOR - RX16



## OVERVIEW

SIZE 24"  
22"  
20"

Part No.  
C24DXE8160002  
Available  
Available



## RIM

TYPE DX188, Double Wall  
MATERIAL Aluminium  
COLOR Silver/Black

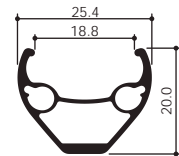

## HUB

TYPE E Type  
MATERIAL Aluminium  
COLOR Silver/Black



R8



12.7 mm



50.8 mm



65.2 mm



## SPOKE

TYPE 12G,1 cross  
QTY 16 pcs  
MATERIAL Steel  
COLOR Black / Orange&Black / Orange&White / Multi-color customized matching



## ART WORK

CONTENT RIANT WHEEL / Customized  
TYPE laser engraving / Decal

[Welcome to contact us for more information.](#)



2024 NEW!

# SUPERIOR - RXR



## OVERVIEW

SIZE 24"  
22"  
20"

Part No.  
B24DXR8200000  
Available  
Available



## RIM

TYPE DX188, Double Wall  
MATERIAL Aluminium  
COLOR Silver/Black

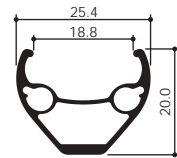

## HUB

TYPE R Type  
MATERIAL Aluminium  
COLOR Silver/Black



## SPOKE

TYPE 12G, Radial  
QTY 20 pcs  
MATERIAL Steel  
COLOR Black / Multi-color customized matching



## HANDRIM

TYPE Hard Anodized  
MOUNTING Welded (4N)  
MATERIAL Aluminum  
COLOR Black  
Weight 375g ± 1% ( 24")



[Welcome to contact us for more information.](#)



# Parts for Spoke Wheels

RIMS

HUBS

HANDRIMS

QUICK RELEASE

DRUM BRAKE

PU TIRE



## RIMS

Code principles :

<b>R</b>	<b>24</b>	<b>P6N</b>	<b>20</b>	<b>A</b>	<b>S</b>	<b>B</b>	<b>01</b>
↓	↓	↓	↓	↓	↓	↓	
size:	type :	spoke holes :	material:	finish:	color:		
24"	P6N	20	A (Aluminum 6061)	S (Anodizing)	B (Black)		
22"	P7N	28		H (Hard anodizing)	S (Silver)		
20"	P8T	36					
18"	P26						
16"	188 (DX188)						
14"							

\*The others, please contact us.



Part No.  
R24P6NxxASB01

### P6N - Single Wall Aluminium Rim

Size available: 14" / 16" / 18" / 20" / 22" / 24"  
 Tire width : 1.5"~1.75"  
 Color : Black / Silver / Others  
 Hand Rim : Unavailable  
 Spoke holes : 20/28/36

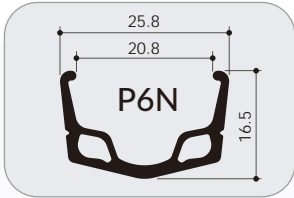

Part No.  
R24P7NxxASB01

### P7N - Single Wall Aluminium Rim

Size available: 14" / 16" / 18" / 20" / 22" / 24"  
 Tire width : 1.5"~1.75"  
 Color : Black / Silver / Others  
 Hand Rim : Available  
 Spoke holes : 20/28/36

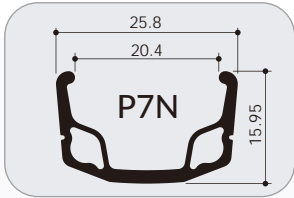

Part No.  
R24P8TxxASB01

### P8T - Single Wall Aluminium Rim

Size available: 14" / 16" / 18" / 20" / 22" / 24"  
 Tire width : 1.75"~2.125"  
 Color : Black / Silver / Others  
 Hand Rim : Available  
 Spoke holes : 20/28/36

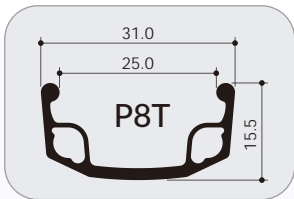

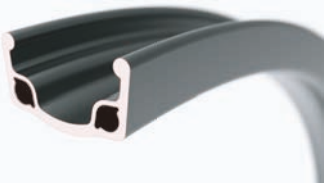

Part No.  
R24P26xxASB01

### P26 - Single Wall Aluminium Rim

Size available: 14" / 16" / 18" / 20" / 22" / 24"  
Tire width : 1", 1<sup>3</sup>/<sub>8</sub>"  
Color : Black / Silver / Others  
Hand Rim : Available  
Spoke holes : 20/28/36

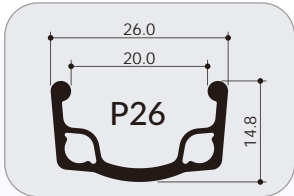

Part No.  
R24188xxAHS01

### DX188 - Double Wall Aluminium Rim

Size available: 20" / 22" / 24"  
Tire width : 1", 1<sup>3</sup>/<sub>8</sub>"  
Color : Black / Silver / Others  
Hand Rim : Available  
Spoke holes : 20/28/36

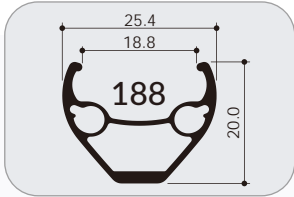

## HUBS

Code principles :

<b>R</b>	<b>C</b>	<b>6</b>	<b>20</b>	<b>50</b>	<b>41</b>	<b>A</b>	<b>S</b>	<b>S</b>	<b>0</b>
	↓	↓	↓	↓	↓	↓	↓	↓	
	type:		spoke holes:			material:	finish:	color:	
C		6 (6001)	20	50 (50.0)	41 (41.0)	A (Aluminum 6061)	S (Anodizing)	S (Silver)	
M		8 (R8)	28	63 (63.5)	53 (53.0)	C (A356+SPHC)	H (Hard anodizing)	B (Black)	
N			36	66 (66.0)	43 (43.2)				
L				79 (79.0)	48 (48.5)				
D									
R									
E									

\*All sizes adjustable



Part No.  
RC6xx5041ASS0  
RC8xx5041ASS0

### Aluminium Hub - C type

Material : Aluminium 6061-T6  
Color : Black / Silver / Others  
Spoke Holes : 20/28/36

6001	12.0 mm	41.0 mm	50.0 mm
R8	12.7 mm	41.0 mm	50.0 mm

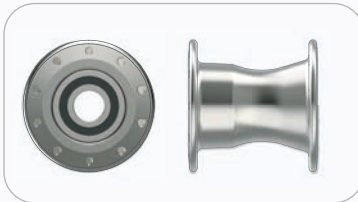

Part No.  
RM6xx6353ASS0  
RM8xx6353ASS0

### Aluminium Hub - M type

Material : Aluminium 6061-T6  
Color : Black / Silver / Others  
Spoke Holes : 20/28/36

6001	12.0 mm	50.0 mm	63.5 mm
R8	12.7 mm	50.0 mm	63.5 mm



Part No.  
RN6xx6353ASS0  
RN8xx6353ASS0

### Aluminium Hub - N type

Material : Aluminium 6061-T6  
Color : Black / Silver / Others  
Spoke Holes : 20/28/36

6001	12.0 mm	53.0 mm	63.5 mm
R8	12.7 mm	53.0 mm	63.5 mm

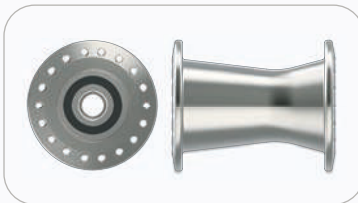



Part No.  
RL6xx6353ASS0  
RL8xx6353ASS0

## Aluminium Hub - L type

Material : Aluminium 6061-T6  
Color : Black / Silver / Others  
Spoke Holes : 20/28/36



6001  
R8



12.0 mm  
12.7 mm



53.0 mm  
53.0 mm



63.5 mm  
63.5 mm

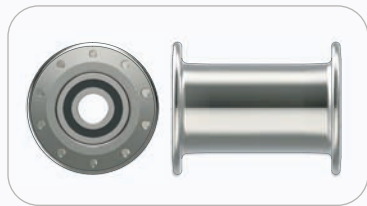

Part No.  
RD6xx6353ASS0  
RD8xx6353ASS0

## Aluminium Hub - D type

Material : Aluminium 6061-T6  
Color : Black / Silver / Others  
Spoke Holes : 20/28/36



6001  
R8



12.0 mm  
12.7 mm



53.0 mm  
53.0 mm



63.5 mm  
63.5 mm

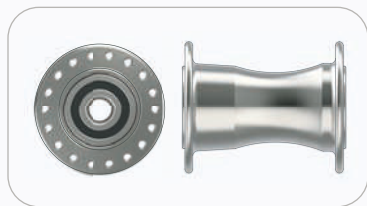

Part No.  
RR6xx6648ASS0  
RR8xx6648ASS0

## Aluminium Hub - R type

Material : Aluminium 6061-T6  
Color : Black / Silver / Others  
Spoke Holes : 20/28/36



6001  
R8



12.0 mm  
12.7 mm



48.5 mm  
48.5 mm



66.0 mm  
66.0 mm



Part No.  
RE6xx6648ASS0  
RE8xx6648ASS0

## Aluminium Hub - E type

Material : Aluminium 6061-T6  
Color : Black / Silver / Others  
Spoke Holes : 16/20/28/36



6001  
R8



12.0 mm  
12.7 mm



50.8 mm  
50.8 mm



65.2 mm  
65.2 mm





## HANDRIMS

Code principles :

<b>R</b>	<b>F</b>	<b>24</b>	<b>6</b>	<b>N4</b>	<b>A</b>	<b>SD</b>	<b>B</b>	<b>01</b>
↓	↓	↓	↓	↓	↓	↓	↓	
Rim Section:	type:	pipe Φ:	Mounting Type:	material:	finish:	color:		
F : ○	24 22 20	6	N4 (Welded-4joints) N6 (Welded-6joints) H4 (Rivnuts-4joints) H6 (Rivnuts-6joints)	A (Aluminum 6061) T (Titanium) S (Stainless Steel)	SD (Anodizing) HD (Hard anodizing) NL (Original Color)	B (Black) S (Silver) C (Colorful) N (Original Steel)		

\*The others, please contact us.

### Hand Rim Splice Types :

Welded (N type)



Rivnuts (H type)



Part No.  
RF246xxASDS01

#### Economic Hand Rim

Material : Aluminum 6061 Anodized  
Color : Black / Silver / Original  
Avaliable Adapt : 24" / 22" / 20".  
Mounting Type : N4/H4/N6/H6



Part No.  
RF246xxSNLN01

#### Stainless Steel Hand Rim

Material : Original Stainless Steel  
Color : Original  
Avaliable Adapt : 24" / 22" / 20".  
Mounting Type : N4/H4/N6/H6





Part No.  
RF246xxAHDB01

## Hard Anodized Hand Rim

Material : Aluminum 6061 Hard Anodized  
Color : Black / Silver / Original  
Avaliable Adapt : 24" / 22" /20"  
Weight : 375g ± 1% ( 24")  
Mounting Type : **N4/N6**



Part No.  
RF246xxTNLS01

## Titanium Series Hand Rim

Material : Titanium  
Color : Original (Anodized)  
Avaliable Adapt : 24" / 22" /20"  
Weight : 318g ± 1% ( 24")  
Mounting Type : **N4/N6**

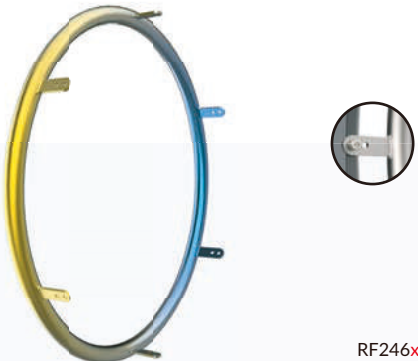

Part No.  
RF246xxTNLC01

## Titanium Series Hand Rim

Material : Titanium  
Color : Colorful (PVD)  
Avaliable Adapt : 24" / 22" /20"  
Weight : 318g ± 1% ( 24")  
Mounting Type : **N4/N6**



## QUICK RELEASE

Code principles :

R	<u>120</u> ↓	<u>42</u> ↓	<u>S</u> ↓	<u>CS</u> ↓	<u>E</u> ↓	<u>S</u> ↓	01
	outer diameter:	length (inch) :	nut :	material:	finish:	color:	
	120 (12.0 mm)	35 (3.50 inch)	S (Standard)	CS (SAE 4130)	E (ED)	B (Black)	
	127 (12.7 mm)	37 (3.75 inch)	N (Economic)		P (Plating)	S (Silver)	
	058 (5/8")	40 (4.00 inch)	B (Big Head)				
		42 (4.25 inch)					
		45 (4.50 inch)					
		47 (4.75 inch)					
		50 (5.00 inch)					
		52 (5.25 inch)					

\*The others, please contact us.



Part No.  
R12042SCSPS01

### Standard

Color Available : Black / Chrome

Dimensions :

- 12.0mm & 12.7mm(1/2")
- 3.5", 3.75", 4.00", 4.25", 4.50", 4.75", 5.00", 5.25"
- 2 lock pins
- Details please refer our drawing



Part No.  
R12742NCSPS01

### Economic

Color Available : Black / Chrome

Dimensions :

- 12.0mm & 12.7mm(1/2")
- 3.5", 3.75", 4.00", 4.25", 4.50", 4.75", 5.00", 5.25"
- 2 lock pins
- Details please refer our drawing



Part No.  
R05847BCSPS01

### Big Head

2024 NEW!

Color Available : Black / Chrome

Dimensions :

- 5/8"
- 4.25", 4.75"
- 4 lock pins
- Details please refer our drawing



DRUM BRAKE



Part No.  
RB8xx7943C0S0

Aluminum hub for Drum Brake - B type

Aluminum Hub + Steel Break Inner Wall  
Foging & CNC / A356+SPHC  
Color Available : Silver / ED Black  
Spoke Holes : 20/28/36

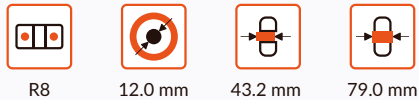

Part No.  
R60DBA12EDB01

Drum Brake

Foging & CNC / ADC12  
Color Available : ED Black

# PU Solid Tire

Never better than PU Solid Tire you feel before.

---

## High Rebound & Ultra Light Weight

1. Specialized PU Material Formular
2. Efficiency & Effectiveness
3. Suitable for Multi-Type Pavement
4. Anti-puncture
5. Pneumatic Resilience Feeling

## Gradient Hardness

1. Enhanced support efforts
2. Improve the omnidirection rotation flexibility
3. Light Weight & Solid



## TIRE

Code principles :

<b>R</b>	<b>24</b>	<b>138</b>	<b>SD</b>	<b>PU</b>	<b>B</b>	<b>01</b>
	↓	↓	↓	↓	↓	
	size (inch) :	width (inch) :	Tire tread :	material :	color:	
	16	138 (1 <sup>3</sup> / <sub>8</sub> inch)	SD (Standard)	PU	B (Black)	
	20	175 (1.75 inch)	SP (Sport)		G (Gray)	
	22					
	24					

\*The others, please contact us.



### Standard Type

Size Available :

24"x1<sup>3</sup>/<sub>8</sub>" , 22"x1<sup>3</sup>/<sub>8</sub>" , 20"x1<sup>3</sup>/<sub>8</sub>"

Tire Color Available : Black / Gray

Part No.  
Rxx138SDPUB01



### Sports Type

Size Available :

24"x1<sup>3</sup>/<sub>8</sub>" , 16"x1.75"

Tire Color Available : Black / Gray

Part No.  
Rxx138SPPUG01



# Parts & Accessories for Wheel Chair



Model No.  
ALA25BVE0BB01

## LA25- 10" Arm Rest

Material :  
ABS + Flame Retardant PVC forming (1.0mm Black cover).  
EVA Inside  
M5 screws Brass Nut Pre-Insert. / Screws 4 pcs



Model No.  
ALA26BVE0BB01

## LA26- 14" Arm Rest

Material :  
ABS + Flame Retardant PVC forming (1.0mm Black cover).  
EVA Inside  
M5 screws Brass Nut Pre-Insert. / Screws 4 pcs



Model No.  
ALA26BVE0BB01

## FW10- 14" Leg Rest

Material :  
ABS + Flame Retardant PVC forming (1.0mm Black cover).  
M6 \* 4 screws Brass Nut Insert.  
Size : 242 x 153 mm.



Model No.  
PHDRTPU000B00

## Head Rest

Material :  
PU Form molding.  
With accessories  
Suitable for 25mm ball-nut



Model No.  
WH151100SB00

## WH1511- Anti-Tipping

Material :  
PA6+GF20%  
Aluminum 6061  
Suitable for the Wheelchair 1" & 7/8" Tube.



# Parts & Accessories for Wheel Chair



Model No.  
 AFWFSL195SBV0  
 AFWFSL195DBV0  
 AFWFSL270SBV0  
 AFWFSL270DBV0

## Walker Front Tube Series

Material : Aluminum tube with Nylon Rim + PVC Tire

L 195mm + 5" Single Wheel  
 L 195mm + 5" Double Wheel  
 L 270mm + 5" Single Wheel  
 L 270mm + 5" Double Wheel

Single Wheel (S) / Double Wheel (D)  
 Color Available : Black Rim (B) + Gray Tire (V)



Model No.  
 PNF10B0000B00  
 PNF12B0000B00  
 PNF14B0000B00  
 PNF16B0000B00

## NF Series- Foot Pedal

Material : PA6(Nylon) + GF15%

A - (10 inch)  
 A - (12 inch)  
 A - (14 inch)  
 A - (16 inch)

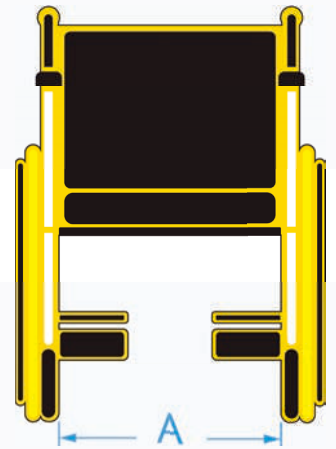

Model No.  
 PMF14B0000B00  
 PMF16B0000B00  
 PMF18B0000B00

## MF Series- Foot Pedal

Material : PA6(Nylon) + GF15%

A - (14 inch)  
 A - (16 inch)  
 A - (18 inch)



Model No.  
 PAF03x0000B00  
 PAF04x0000B00

## AF Series- Foot Pedal

Material : Aluminum with Anodizing

08" - 203 x 135 mm / Thickness 4.0mm  
 10" - 254 x 135 mm / Thickness 4.0mm



Model No.  
 AH1SFBBRYOM00  
 AH1SFBBRYOP00

## RNS Series- Safety Belt

Material :

Metal Buckle - 170 cm (75")  
 Plastic Buckle - 170 cm (75")





# Soft Caster for Office Chair

## Any surface easy, quiet & smooth rolling

1. Specialized PU Material Fomular
2. Efficiency & Effectiveness
3. Suitable for Multi-Type Pavement
4. Anti-puncture



### RNOS for office chairs

Model No.  
RNOCNC680900x

Material :  
Nylon Fork / Rim + PVC Tire - Green(01) / Black(02)  
Color Customized Available : Please contact us.

## Test passed BIFMA X5.1-2017

BIFMA Test Report - tested by SGS (Taiwan)

BIFMA X5.1-2017 Clause 16.1 - Criteria :

No lost of service after 2,000 cycles over a hard surface with 3 obstacles and 98,000 cycles over a smooth hard surface without obstacles under a 122 kg (270lbs.) load on the seat...

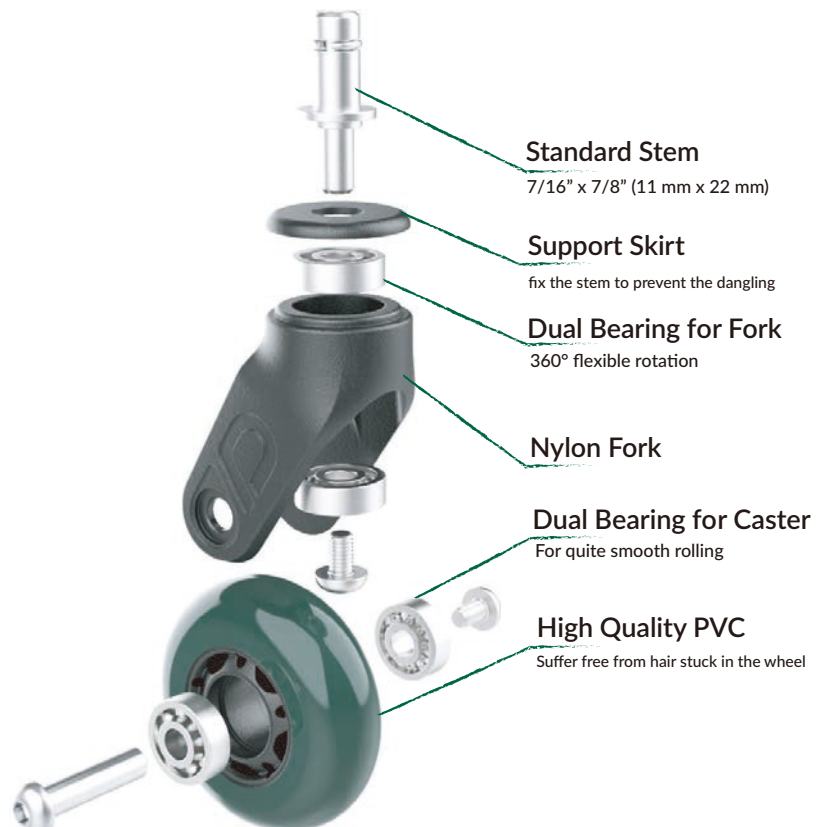

# Medical Universal Silent Wheel

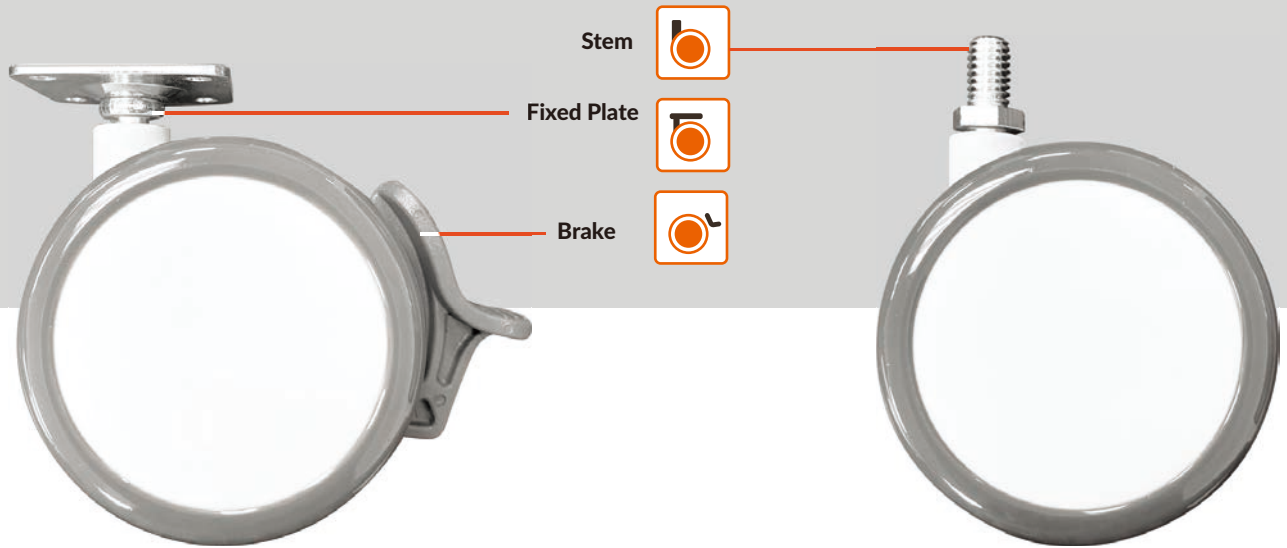

Part No.  
TB022K5E19200



3" (75.0mm)



54.0mm



H.D.T

75°C



Part No.  
TB022K5E19300



3" (75.0mm)



54.0mm



H.D.T

75°C



Brake



Part No.  
TB022K5E19100



3" (75.0mm)



54.0mm



H.D.T

75°C



3/8"



Part No.  
TB022K5E19000



3" (75.0mm)



54.0mm



H.D.T

75°C



3/8"









Brake



# Medical Universal Silent Wheel







Part No.  
TB022K5E24000

-  3" (75.0mm)
-  54.0mm
-  H.D.T.  
75°C
-  Fixed Plate
-  42x42mm
-  30.0mm
-  5.0mm











Part No.  
TB022K5E23000

-  3" (75.0mm)
-  54.0mm
-  H.D.T.  
75°C
-  Fixed Plate
-  54x54mm
-  42.0mm
-  6.2mm











Part No.  
TB022K5E24100

-  3" (75.0mm)
-  54.0mm
-  H.D.T.  
75°C
-  Brake
-  Fixed Plate
-  42x42mm
-  30.0mm
-  5.0mm



Part No.  
TB022K5E23100

-  3" (75.0mm)
-  54.0mm
-  H.D.T.  
75°C
-  Brake
-  Fixed Plate
-  54x54mm
-  42.0mm
-  6.2mm



# OUR QUALITY POLICY & COMMITMENT



 **SATISFIED /**  
Customer-first, supreme quality & innovative service

 **TRUSTWORTHY /**  
Deliver reliable & trusted services with diligence

 **INNOVATIVE /**  
Consistently innovative design to meet customer needs

 **KEEP-IMPROVING /**  
Continuously improving & striving for excellence

---

## ISO:9001 coming soon...





## CONTACT US

email : [sales@riantwheel.com](mailto:sales@riantwheel.com)

Natural Technology Co., LTD

TEL: +886-2-8521-3009 / FAX: +886-2-8521-3801

Room B, 2F.-1, No.5, Sec. 3, New Taipei Blvd., Xinzhuang Dist., New Taipei City (24250), Taiwan

Riant Wheel® is the registered brand by Natural Technology Co., LTD

All the copy right of the pictures, drawing are owned by Natural Technology Co., LTD.

DO NOT use without legal permission.

*Thanks for [Kelly Lai](#) & [Tania Chen](#) make Riant Wheel growth up by used their wilsdom & mild .*

[www.riantwheel.com](http://www.riantwheel.com)



**RIANT WHEEL®**

Design & Made in Taiwan.